

# EXSITE ENHANCED BISPECTRAL PTZ 2 SERIES

2 MP

320 x 256

640 x 512

## SEE THE UNSEEN: UNITING THERMAL AND VISUAL IN ONE EXPLOSION-PROOF CAMERA

Hazardous applications pose a unique set of challenges. Superior visibility and situational awareness is paramount when posed with varying environmental and lighting conditions.

The ExSite Enhanced Bispectral PTZ 2 Series is an explosion-proof camera that combines visual and thermal imaging into a single device to optimize contextual insight. The thermal camera can accurately detect a target in most environmental conditions, while the visual camera achieves greater recognition and identification. Built with durable stainless steel, this camera is tailored for hazardous and corrosive industries, such as onshore/offshore oil and gas, manufacturing, chemical and more.



## FEATURES



### VISUAL CAMERA

Get clear images in most weather and lighting conditions with 2 MP resolution, LowLight Technology and True Wide Dynamic Range. Get a complete picture with the smooth movement of the PTZ and see afar with long-range zoom.



### EXPLOSION-PROOF

The heavy-duty housing meets stringent explosion-proof and dust-ignition-proof requirements while complying with international standards (UL, CSA, ATEX, IECEx, EACEx, INMETRO, KCs, UKCA).



### READY FOR HARSH CONDITIONS

Safe within a wide temperature range, from -40°C to +60°C (-40°F to 140°F), plus NEMA Type 4X/6P and IP66/67/68/69 weather rating for maximum durability in tough environments.



### PELCO SMART ANALYTICS

Powered by Motorola Solutions. Make quicker, decisive responses with enhanced object detection and classification and leverage your PTZ's full potential with auto-tracking.



### THERMAL CAMERA

Detect heat signatures from a long distance with various resolutions, including QVGA and VGA, and choose from a variety of field-of-view options to cover wide areas.



### SUPERIOR DETECTION

Never miss a single detail with a camera that provides a thermal and a visual vision for better decision-making and reduced false alarm rates.



### EASY INSTALLATION

Simplify installation and ensure cost-efficiency by installing only one camera instead of two. Take advantage of flexible mounting options to suit your facility's needs, particularly in remote and challenging sites.



### ONVIF® CONFORMANT

ONVIF Profile S, G, T and M conformance for easy integration with leading video management software to maximize existing investments.

ONVIF is a trademark of Onvif, Inc.

For more information, contact your local Pelco sales representative today at [pelco.com/about/contact-us/#form](https://pelco.com/about/contact-us/#form).

# SPECIFICATIONS

THERMAL - IMAGE PERFORMANCE	QVGA	VGA
Image Sensor	320 x 256 Uncooled VOx Microbolometer	640 x 512 Uncooled VOx Microbolometer
Dynamic Range	-40°C to 225°C (-40°F to 437°F)[may vary based on operating temperature]	
Image Rate	Up to 30 fps (-1 models up to 8.6 fps)	
Aspect Ratio (Resolution Scaling)	5:4	
3D Noise Reduction Filter	Yes	
Pixel Pitch	12µm	
Spectral Range	8µm to 14µm	
Image Sensor	320 x 256, can be scaled up to 640 x 512	640 x 512, can be scaled down to 320 x 256
Sensitivity	NETD ≤50 mK (NETD ≤40 mK on 30 fps models when Frame Averager feature is enabled)	
Thermal Palettes	White Hot, Black Hot, Rainbow, RainHC, IronBow, Lava, Artic, GlowBow, GradedFire, Hottest	
Image Uniformity Optimization	Automatic Flat Field Correction (FFC) - Thermal and Temporal	

THERMAL - LENS	QVGA		VGA	
Lens	6.3 mm	18 mm	14 mm	24 mm
Horizontal field of view	34°	12°	32°	12.2°
Vertical field of view	27.2°	9.6°	25.6°	9.8°
F-number	F/1.01	F/1.04	F/1.00	F/1.00

VISIBLE - IMAGE PERFORMANCE	2.0 MP	
Image Sensor	1/3" progressive scan CMOS	
Active Pixels (H x V)	1944 (H) x 1212 (V)	
Imaging Area (H x V)	5.568 mm (H) x 3.132 mm (V); 0.219 " (H) x 0.123 " (V)	
Minimum Illumination	0.05 lux (1/30s, 60dB) in color mode; 0.005 lux (1/30s, 60dB) in monochrome	
Dynamic Range	Up to 120 dB	
Image Rate	Up to 60 fps	
Aspect Ratio (Resolution Scaling)	Down to (16:9) 384x216 or (5:4) 320x256	
Lens	F1.6, 4.3-129 mm (30x zoom) remote focus and zoom	
Angle of View	Horizontal	(16:9) 2.34° - 65.1°
	Vertical	(16:9) 1.36° - 38.4°
Zoom	Up to 30x	
3D Noise Reduction Filter	Yes	

\* The distances and the performance depend on the environmental conditions. Illumination activation by software can be activated via presets or the zoom factor, based on the scene brightness, from alarm input or manually.

VISIBLE - IMAGE CONTROL	2.0 MP
Motion Detection	Pixel motion: Selectable sensitivity and threshold. Classified object detection
Electronic Shutter Control	Automatic, Manual (1/1 to 1/10,000 sec)
Iris Control	Automatic, Open, Closed
Day/Night Control	Automatic, Manual
Flicker Control	60 Hz, 50 Hz
White Balance	Automatic, Manual
Backlight Compensation	On/Off

VISIBLE - IMAGE CONTROL	
Privacy Zones	2.0 MP 3D, up to 64 zones
Electronic Image Stabilization	No
Digital Defog	Adjustable/Off

COMMON - IMAGE CONTROL	
Video Compression	H.264 and H.265 Pelco Smart Compression, Motion JPEG
Streaming	Multi-stream H.264, Multi-stream H.265, Motion JPEG
Presets	500 named presets
Tours	10 named tours

NETWORK	
ONVIF	ONVIF compliance Profile S, Profile T, Profile G, and Profile M ( <a href="http://www.onvif.org">www.onvif.org</a> )
Security	Password protection, HTTPS encryption, digest authentication, WS authentication, user access log, 802.1x port based authentication
Protocols	IPv6, IPv4, HTTP, HTTPS, SOAP, DNS, NTP, RTSP, RTCP, RTP, TCP, UDP, IGMP, ICMP, DHCP, Zeroconf, ARP, SNMP v2c, SNMP v3

MECHANICAL	
Dimensions (LxWxH)	453 mm x 232 mm x 398 mm; 17.84" x 9.13" x 15.7"
Weight	35 kg; 77 lbs
Construction	AISI 316L stainless steel
Finish	Electro-polished surface
Pan Movement	360° continuous, max 100°/s
Vertical Tilt	-90° to 90°
Maximum Pan/Tilt Speed	100°/s
Wiper	Yes
Cable Entry	2 x 3/4" NPT

ELECTRICAL	
Local Storage	Factory installed 128GB, Micro SDXC Card.
Ports	10BASE-T/100BASE-TX, RJ45 connector (CAT5E cabling) and SFP slot
Power Consumption	120 W
Input Voltage (Power)	Ordering options: 230 VAC, 0.54 A, 50/60 Hz 24 VAC, 5A, 50/60 Hz 120 VAC, 1A, 50/60 Hz 220 VAC, 0.54A, 50/60 Hz
Input for Remote Reset	1
Alarm Inputs	1
Relay Outputs	1+1 (one relay reserved for washer pump and one configurable, 1A, 30 VAC/60 VDC max)

ENVIRONMENTAL	
Operating Temperature	-40 °C to +55 °C (-40 °F to 131 °F) in enclosed space, -40 °C to +60 °C (-40 °F to 140 °F) with ambient convection
Storage Temperature	-40 °C to +55 °C (-40 °F to 131 °F)
Humidity	5% - 95% non-condensing
Cold Start	Up to 2 hour startup delay at temperature lower than -10 °C (14 °F)
Wind Resistance	Pan and tilt operational at a maximum of 210 km/h wind (130.5 mph)





## CERTIFICATIONS

Certifications/Directives	cULus, CE, UKCA, ROHS, RCM
Safety	UL/CSA 62368-1, EN/IEC 62368-1
Hazardous	ATEX (EN IEC 60079-0, EN 60079-1, EN 60079-31), IECEx (IEC 60079-0, IEC 60079-1, IEC 60079-31), EAC EX (TR CU 012/2011), INMETRO (ABNT NBR IEC 60079-0, ABNT NBR IEC 60079-1, ABNT NBR IEC 60079-31), UK Ex (EN IEC 60079-0, EN 60079-1, EN 60079-31), KCs (Employment and labor department 2021-22), UL listed for USA (UL 60079-0, UL 60079-1, UL 60079-31), UL listed for Canada (CAN/CSA-C22.2 NO. 60079-0, CAN/CSA-C22.2 NO. 60079-1, CAN/CSA-C22.2 NO. 60079-31)
Environmental and Performance	EN/IEC 60529: IP66, IP67, IP68, IP69 IEC 60068-2-1, IEC 60068-2-2, IEC 60068-2-6, IEC 60068-2-30, IEC 60068-2-52 NEMA TS 2 para 2.2.7 - 2.2.9 UL50E: Type 4X and 6P
Electromagnetic Emissions	FCC Part 15 Subpart B Class A, IC ICES-003 Class A, EN 55032 Class A, EN 61000-6-4, EN 61000-3-2, EN 61000-3-3
Electromagnetic Immunity	EN 50130-4
Vibration Test	EN 50130-5, EN 60068-2-6
Warranty	3-year limited warranty. 5-year extended warranty is available.

## CERTIFICATIONS - MARINE APPLICATIONS

Lloyd's Register Marine Type Approval certification (with MAXIMUS MBX communication box or with FM1010 filter)	Test Specification Number 1 (ENV1, ENV2, ENV3, ENV5)
Electromagnetic Compatibility	EN60945
Salty Fog Resistance	EN60068-2-52

## EXPLOSION-PROOF CERTIFICATIONS

PART NUMBER	CERTIFICATION	MARKING	AMBIENT TEMPERATURE	CABLE ENTRY TEMPERATURE
EXBE2-2X30VF14-SPT-M2G-1 EXBE2-2X30VF14-SPT-M2G EXBE2-2X30VF14-SPT-M1G-1 EXBE2-2X30VF14-SPT-M1G EXBE2-2X30VF14-SPT-ACG-1 EXBE2-2X30VF14-SPT-ACG EXBE2-2X30VF14-SPT-M5G-1 EXBE2-2X30VF14-SPT-M5G EXBE2-2X30VF24-SPT-M2G-1 EXBE2-2X30VF24-SPT-M2G EXBE2-2X30VF24-SPT-M1G-1 EXBE2-2X30VF24-SPT-M1G EXBE2-2X30VF24-SPT-ACG-1 EXBE2-2X30VF24-SPT-ACG EXBE2-2X30QF06-SPT-M5G-1 EXBE2-2X30QF06-SPT-M5G EXBE2-2X30QF18-SPT-M2G-1 EXBE2-2X30QF18-SPT-M2G EXBE2-2X30QF18-SPT-M1G-1 EXBE2-2X30QF18-SPT-M1G EXBE2-2X30QF18-SPT-ACG-1 EXBE2-2X30QF18-SPT-ACG EXBE2-2X30QF18-SPT-M5G-1 EXBE2-2X30QF18-SPT-M5G	DEMKO 12 ATEX 1031198X  IECEx ULD 11.0005X  EAЭ C RU C - IT.HA91.B.00274/22  INMETRO UL-BR 13.0063X  16-KA4B0-0309X, 16-KA4B0-0310X  UKEx UL21UKEX2216X	 II 2G Ex db IIC T6...T5 Gb  II 2D Ex tb IIIC T85°C...T100°C Db  Ex db IIC T6...T5 Gb Ex tb IIIC T85°C...T100°C Db  1Ex db IIC T6...T5 Gb X Ex tb IIIC T85°C...T100°C Db X  Ex db IIC T6...T5 Gb Ex tb IIIC T85°C...T100°C Db   II 2G Ex db IIC T6...T5 Gb  II 2D Ex tb IIIC T85°C...T100°C Db	-40°C ≤ Ta ≤ +50°C or +70°C (T6/T85°C with Ta ≤ +50°C) (T5/T100°C with Ta ≤ +70°C)	+81°C Ta ≤ +70°C or +80°C Ta ≤ +69°C
	cULus File E319666 Hazardous Location America  cULus File E319666 Hazardous Location Canada	Class I, Zone 1, AEx db IIC T6...T4 Gb Zone 21, AEx tb IIIC T85°C...T135°C Db Class I, Div 2, Group A, B, C, D T6...T4 Class II, Div 2, Group F, G T6...T4  Ex db IIC T6...T4 Gb X Ex tb IIIC T85°C...T135°C Db X Class I, Div 2, Group A, B, C, D T6...T4 Class II, Div 2, Group F, G T6...T4	-40°C ≤ Ta ≤ +50°C or +65°C or +70°C (T6/T85°C with Ta ≤ +50°C) (T5/T100°C with Ta ≤ +65°C) (T4/T135°C with Ta ≤ +70°C)	+83°C Ta ≤ +70°C or +80°C Ta ≤ +67°C

# ANALYTICS SPECIFICATIONS

SUPPORTED ANALYTICS EVENTS*	
Objects in Area	The event is triggered when the selected object type moves into the region of interest.
Object Loitering	The event is triggered when the selected object type moves into the region of interest, then stays for an extended amount of time.
Objects Crossing Beam	The event is triggered when the specified number of objects have crossed the directional beam that is configured over the camera's field of view. The beam can be unidirectional or bidirectional.
Object Appears or Enters Area	The event is triggered by each object that enters the region of interest and can also be used to count objects.
Object Not Present in Area	The event is triggered when no objects are present in the region of interest.
Objects Enter Area	The event is triggered when the specified number of objects have entered the region of interest.
Objects Leave Area	The event is triggered when the specified number of objects have left the region of interest.
Object Stops in Area	The event is triggered when an object moves into a region of interest and then stops moving for the specified threshold time.
Direction Violated	The event is triggered when an object moves in the prohibited direction of travel.
Sabotage Detection	The event is triggered when the scene unexpectedly changes.

\*Pelco Smart Analytics powered by Motorola Solutions.

## SYSTEM MODEL NUMBERS

RESOLUTIONS & LENS	POWER	FPS	PART NUMBER
Sensor VGA 640x512; Lens 32°-14mm.	230 Vac	9Hz	EXBE2-2X30VF14-SPT-M2G-1
		30Hz	EXBE2-2X30VF14-SPT-M2G
	120 Vac	9Hz	EXBE2-2X30VF14-SPT-M1G-1
		30Hz	EXBE2-2X30VF14-SPT-M1G
	24 Vac	9Hz	EXBE2-2X30VF14-SPT-ACG-1
		30Hz	EXBE2-2X30VF14-SPT-ACG
	220 Vac	9Hz	EXBE2-2X30VF14-SPT-M5G-1
		30Hz	EXBE2-2X30VF14-SPT-M5G
Sensor VGA 640x512; Lens 18°-24mm.	230 Vac	9Hz	EXBE2-2X30VF24-SPT-M2G-1
		30Hz	EXBE2-2X30VF24-SPT-M2G
	120 Vac	9Hz	EXBE2-2X30VF24-SPT-M1G-1
		30Hz	EXBE2-2X30VF24-SPT-M1G
	24 Vac	9Hz	EXBE2-2X30VF24-SPT-ACG-1
		30Hz	EXBE2-2X30VF24-SPT-ACG
	220 Vac	9Hz	EXBE2-2X30VF24-SPT-M5G-1
		30Hz	EXBE2-2X30VF24-SPT-M5G
Sensor VGA 320x256; Lens 34°-6.3mm.	230 Vac	9Hz	EXBE2-2X30QF06-SPT-M2G-1
		30Hz	EXBE2-2X30QF06-SPT-M2G
	120 Vac	9Hz	EXBE2-2X30QF06-SPT-M1G-1
		30Hz	EXBE2-2X30QF06-SPT-M1G
	24 Vac	9Hz	EXBE2-2X30QF06-SPT-ACG-1
		30Hz	EXBE2-2X30QF06-SPT-ACG
	220 Vac	9Hz	EXBE2-2X30QF06-SPT-M5G-1
		30Hz	EXBE2-2X30QF06-SPT-M5G

RESOLUTIONS & LENS	POWER	FPS	PART NUMBER
Sensor VGA 320x256; Lens 12°-18mm.	230 Vac	9Hz	EXBE2-2X30QF18-SPT-M2G-1
		30Hz	EXBE2-2X30QF18-SPT-M2G
	120 Vac	9Hz	EXBE2-2X30QF18-SPT-M1G-1
		30Hz	EXBE2-2X30QF18-SPT-M1G
	24 Vac	9Hz	EXBE2-2X30QF18-SPT-ACG-1
		30Hz	EXBE2-2X30QF18-SPT-ACG
	220 Vac	9Hz	EXBE2-2X30QF18-SPT-M5G-1
		30Hz	EXBE2-2X30QF18-SPT-M5G

## MOUNTING ACCESSORIES

PART #	DESCRIPTION
MPXCW	Corner mount adapter for use with ExSite cameras. Max load 50 kg (110 lb.). AISI 316L stainless steel.
MPXWBA	AISI 316L stainless steel wall bracket.
MPXCOL	Pole mount adapter for use with ExSite cameras. For pole diameters from 110 mm (4.3") to 150 mm (5.9"). Max load 50 kg (110 lb.). AISI 316L stainless steel.
MPXWBTA	AISI 316L stainless steel parapet or ceiling mounting bracket.

## CABLING

ITEM	DESCRIPTION
MPX2CABL41	Cabling, 4m (13.1 ft), unarmored cable, barrier cable gland
MPX2CABL101	Cabling, 10m (32.8 ft), unarmored cable, barrier cable gland
MPX2CABLARM41	Cabling, 4m (13.1 ft), armored cable, barrier cable gland
MPX2CABLARM101	Cabling, 10m (32.8 ft), armored cable, barrier cable gland

## CABLE GLANDS AND ACCESSORIES 3/4" NPT

TYPE	CERTIFICATION	OPERATING TEMP.	CABLE	PART NUMBER	MAXIMUM DIAMETER OF THE EXTERNAL SHEATH (A)	MAXIMUM DIAMETER OF THE INTERNAL SHEATH (B)	MAXIMUM DIAMETER OF THE CONDUCTORS BUNDLE (C)
Barrier Cable Gland	IECEX / ATEX / EAC Ex	-60°C (-76°F) / +135°C (+275°F)	Unarmored	OCTEXB3/4P	20.0 mm (0.78 in)	-	17.8 mm (0.7in)
			Armored	OCTEXBA3/4P	16.8 - 23.9 mm (0.66-0.94 in)	20 mm (0.79 in) max	17.8 mm (0.7 in)
Cable Gland with Gasket	IECEX / ATEX / EAC Ex	-60°C (-76°F) / +100°C (+212°F)	Unarmoured	OCTEX3/4C	13.0 - 20.2 mm (0.51-0.79 in)	-	-
			Armored	OCTEXA3/4C	16.9 - 26.0 mm (0.66-1.02 in)	11.1 - 19.7 mm (0.44 - 0.78 in)	-
	ATEX	-40°C (-40°F) / +100°C (+212°F)	Unarmoured	OCTEX3/4	14.0 - 17.0 mm (0.55-0.67 in)	-	-
			Armored	OCTEXA3/4	18.0 - 23.0 mm (0.71-0.91 in)	14.0 - 17.0 mm (0.55-0.67 in)	-
Plug EX 3/4"NPT	IECEX / ATEX / EAC Ex	-100°C (-148°F) / +400°C (+752°F)	-	OEXPLUG3/4P	-	-	-
Conduit Sealing Fitting	IECEX / ATEX / cCSAus / EAC Ex	-60°C (-76°F) / +80°C (+176°F)	-	OCTEXP3/4C	-	-	11.0 mm (0.43 in)

TYPE	CERTIFICATION	OPERATING TEMP.	CABLE	PART NUMBER	MAXIMUM DIAMETER OF THE EXTERNAL SHEATH (A)	MAXIMUM DIAMETER OF THE INTERNAL SHEATH (B)	MAXIMUM DIAMETER OF THE CONDUCTORS BUNDLE (C)
Reduction 3/4" NPT x 1/2" NPT	IECEX / ATEX / EAC Ex	-100°C (-148°F) / +400°C (+752°F)	-	OCTEX1/2-3/4P	-	-	-

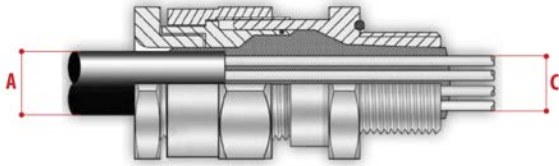

Barrier cable gland with unarmored cable

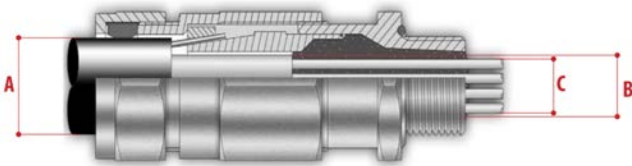

Barrier cable gland with armored cable

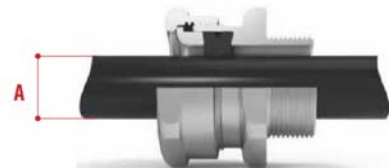

Cable gland with gasket with unarmored cable



Cable gland with gasket with armored cable

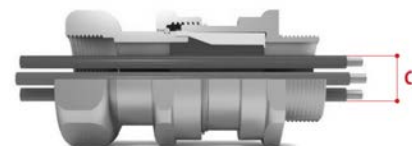

Conduit sealing fitting

## EXPLOSION-PROOF COMMUNICATION BOX

A communication box includes a 3-port RJ45 and 1 SFP port Ethernet switch and 24 VAC output for powering up to one of the following:

- 2x EXC2602 fixed compact cameras
- 2x EXF2230 fixed cameras with 2x washer pump
- 1x EXP2230, EXBE2, or EXPE2 PTZ camera with 1x washer pump

PART #	DESCRIPTION
MBA1S5A	Aluminum housing, 230 VAC input.
MBA2S5A	Aluminum housing, 24 VAC input.
MBA3S5A	Aluminum housing, 120 VAC input.

PART #	DESCRIPTION
MBX1MAA MBX2MAA MBX3MAA	AISI 316L stainless steel housing, 230 VAC input. AISI 316L stainless steel housing, 24 VAC input. AISI 316L stainless steel housing, 120 VAC input.
MBXMP	Adapter plate for communication box to MPXCOL or MPXCW mounts. AISI 316L stainless steel housing.
MBXWRE	Wrench for opening communication boxes, MBX.
MPXCOL	Pole mount adapter for use with ExSite cameras. For pole diameters from 110 mm (4.3") to 150 mm (5.9"). Max load 50 kg (110 lb.). AISI 316L stainless steel.
MPXCW	Corner mount adapter for use with ExSite cameras. Max load 50 kg (110 lb.). AISI 316L stainless steel.

## DIMENSIONS

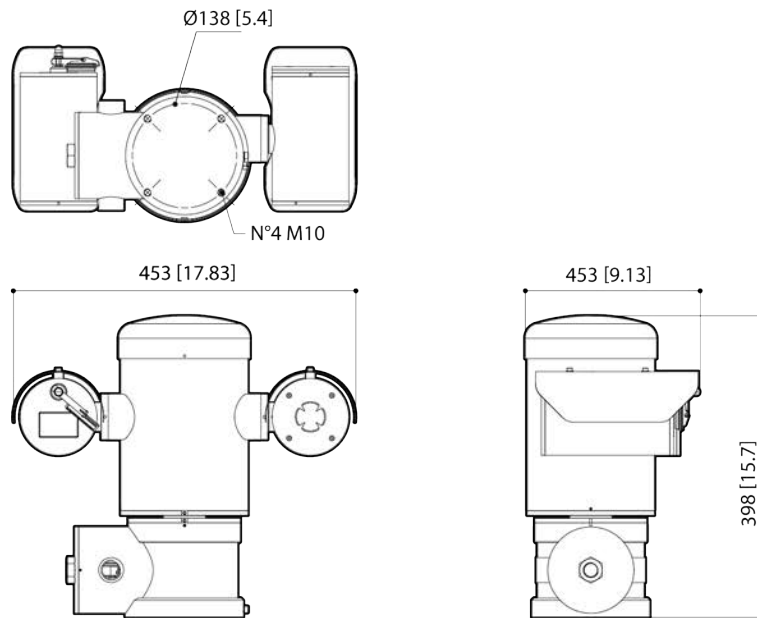

Values in parentheses are inches; all others are millimeters.



# EXPLOSION-PROOF WASHER

A 10L (2.6 gal) tank with integrated manual pump and delivery up to 20m (66 ft), 24 VAC/VDC input.

PART #	DESCRIPTION
WASEX2T4AT WASEX2T4IC WASEX2T4IN WASEX2T4KC WASEX2T4GOR WASEX2T4UL	ATEX certified solenoid valve. IECEX certified solenoid valve. INMETRO certified solenoid valve. KCS certified solenoid valve (only 24 VDC). EAC Ex certified solenoid valve. cULus certified solenoid valve.
NXC0L	Pole mount adapter for use with EXF2230 cameras or explosion protected washers. For pole diameters from 110 mm (4.3") to 150 mm (5.9"). Max load 50 kg (110 lb.). AISI 316L stainless steel.
NXCW	Corner mount adapter for use with EXF2230 cameras or explosion protected washers. Max load 50 kg (110 lb.). AISI 316L stainless steel.

# SUPPORT

Learn more and find additional documentation at [pelco.com](https://pelco.com) or email [support@pelco.com](mailto:support@pelco.com) for specific product support.



Oct 2023 | | Rev 1

© 2023, Motorola Solutions, Inc. All rights reserved. MOTOROLA, MOTO, MOTOROLA SOLUTIONS, and the Stylized M Logo are trademarks or registered trademarks of Motorola Trademark Holdings, LLC and are used under license. Pelco, the Pelco logo, and other trademarks associated with Pelco products referred to in this publication are trademarks of Pelco, Inc. or its affiliates. All other product names and services are the property of their respective companies. Product specifications and availability are subject to change without notice.